

25. Index Of Refraction

Monday, November 28, 2022 7:50 AM

Index of refraction techniques

Requires no seed. Can visualize differences and gradients in temperature and chemical concentration, as both change the index of refraction of the media.
Examples first, then techniques discussed in detail: schlieren and shadowgraphy

Color schlieren

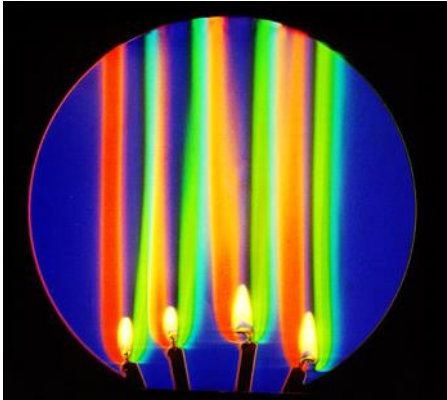

Pasted from
<<http://www.compadre.org/informal/images/features/schlierenlarge-11-29-06.jpg>>

Andrew DAVIDHAZY (retired now),
RIT = Rochester Institute of Technology, offers engineering and BS through PhD in Imaging Science.

SHADOWGRAPH

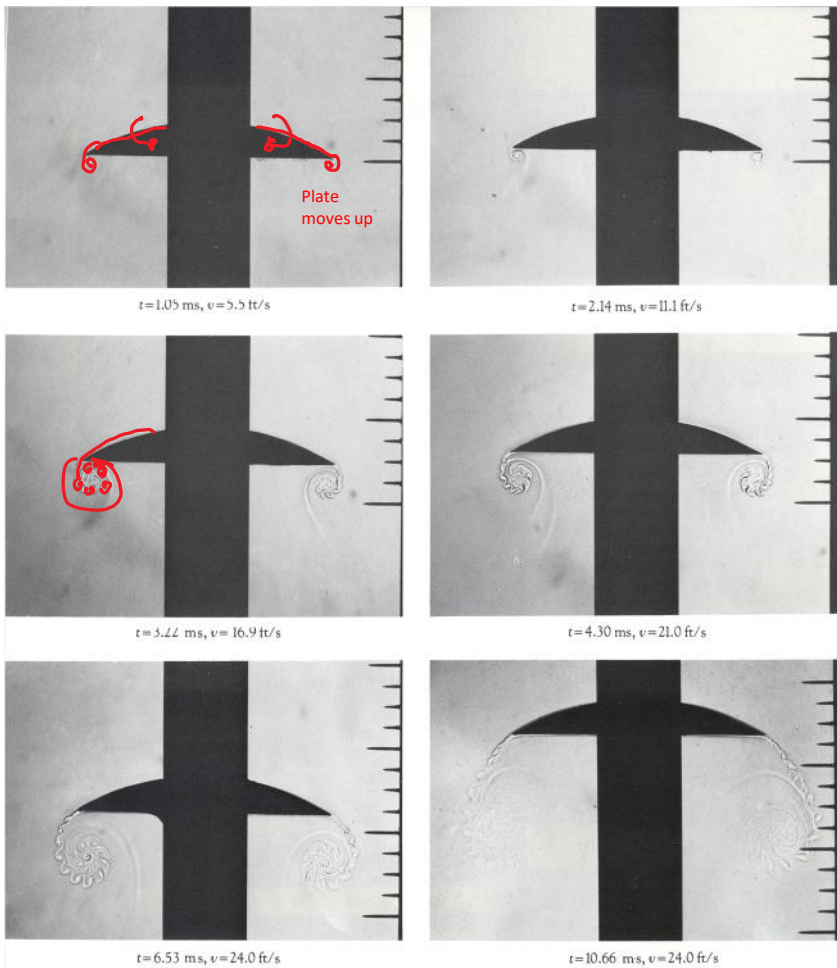

81. Growth of vortices on an accelerated plate. Spark shadowgraphs show the history of a 3-inch-square plate in air, accelerated from rest to 24 ft/s. The sharp edge of the plate is initially opposite the first of a series of pins spaced $\frac{1}{4}$ inch apart. The motion is actually vertical, and the flow is visualized by painting a narrow band of benzene across the center of the balsa-wood plate, so that when the plate

accelerates benzene vapor is drawn into the vortex sheet. The difference in density between the vapor and the air makes the paths of their boundaries visible. Care was taken to ensure that the undulations observed in the vortex sheet were not caused by vibrations of the model. *Pierce 1961*

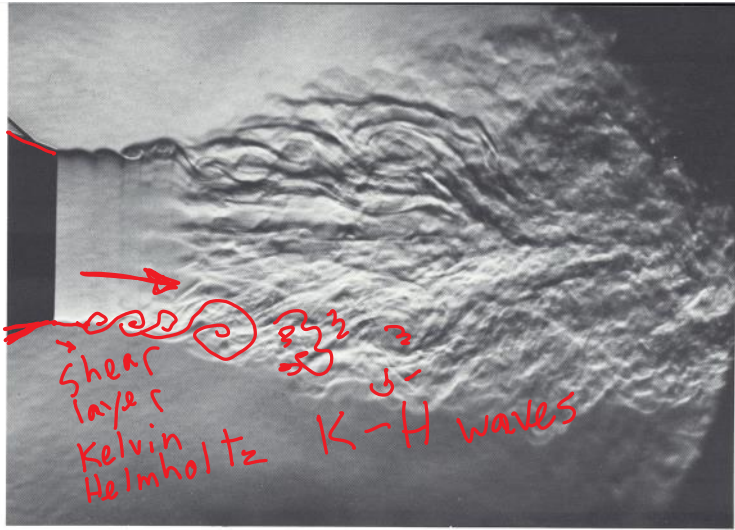

167. Subsonic jet becoming turbulent. A jet of air from a nozzle of 5-cm diameter flows into ambient air at a speed of 12 m/s. The laminar interface becomes unstable as in

figure 102, and the entire jet eventually becomes turbulent. Bradshaw, Ferriss & Johnson 1964

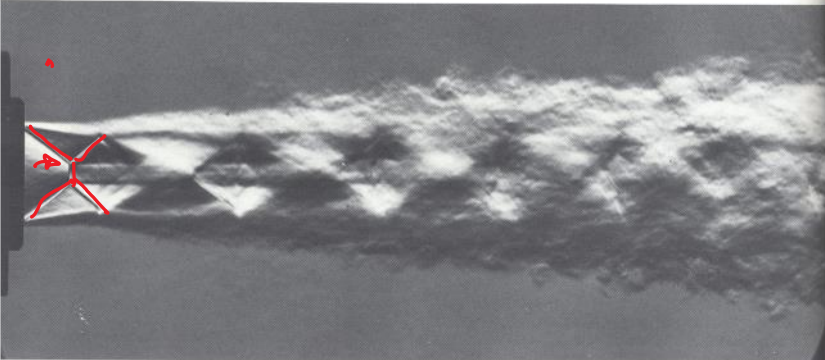

168. Supersonic jet becoming turbulent. At a Mach number of 1.8 a slightly over-expanded round jet of air adjusts to the ambient air through a succession of oblique

and normal shock waves. The diamond-shaped pattern persists after the jet is turbulent. Oertel 1975

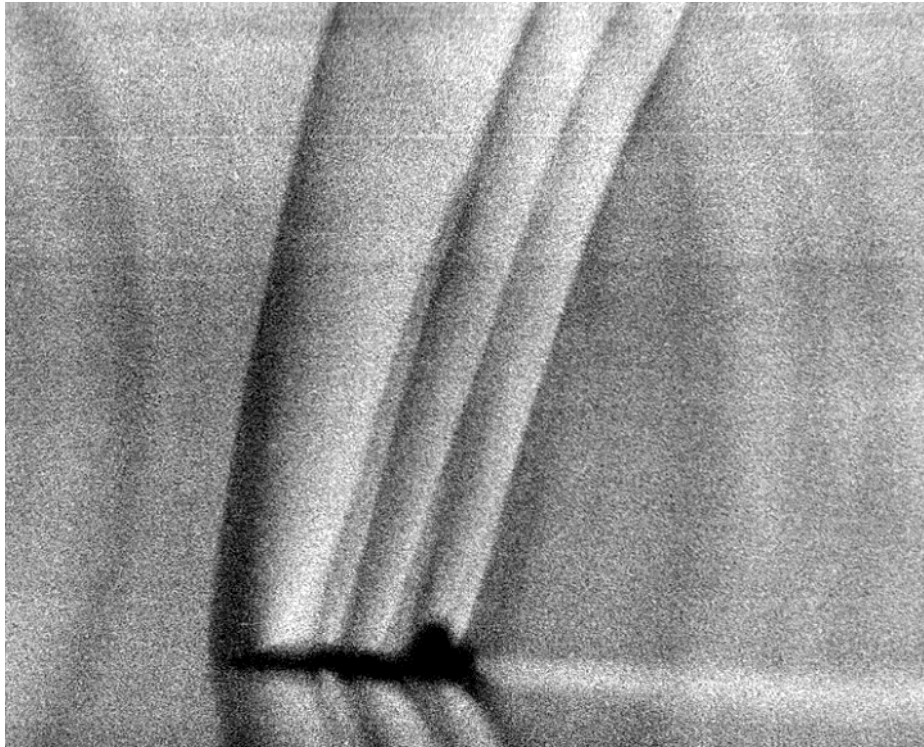

Pasted from <http://commons.wikimedia.org/wiki/File:Schlieren_photograph_of_T-38_shock_waves.jpg>

Mach 1.1, full size T-38 in flight, 1993. L. Weinstein, NASA
 example of Background Oriented Schlieren (BOS). Correlate patterned background from image to get schlieren

<http://fuckyeahfluidynamics.tumblr.com/post/47622561173/this-high-speed-video-shows-schlieren-photography>

CO2 bottle rocket video. Shows Mach diamonds and expansion fans.

How it works:

<http://www.npr.org/2014/04/09/300563606/what-does-sound-look-like>

Michael Hargather, New Mexico Tech

speed of light

$$n = \frac{c_{\text{VACUUM}}}{c_{\text{MEDIUM}}} = \text{eetah} = \quad n = \text{index of refraction}$$

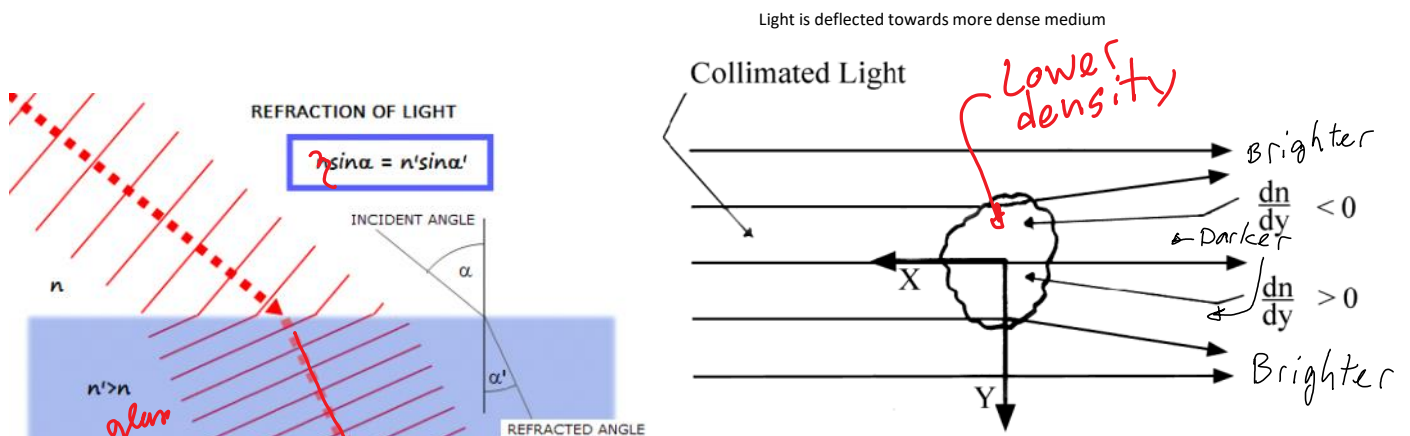

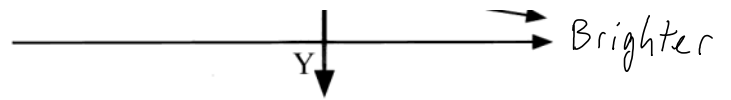
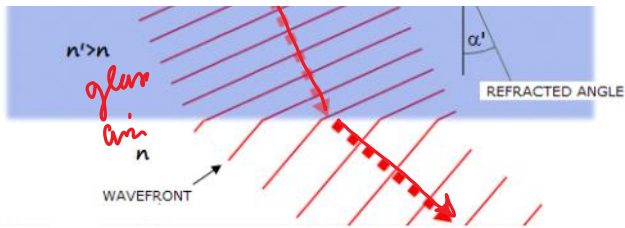

Figure 1. Disturbance in Collimated Beam

Copyright J. Kim Vandiver, 2002

Shadowgraphy:

constructive and destructive interference from disturbed parallel light

like a caustic sunlight

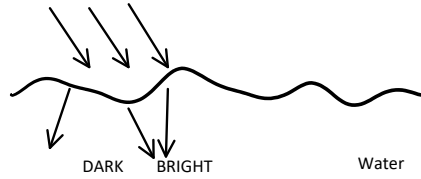

<http://www.shutterstock.com/video/clip-3174052-stock-footage-dappled-pool-water-ripple-background-swimming-pool-water-abstract-background-with-seamless-loop.html>

http://web.mit.edu/Edgerton/www/schliere_n5.html

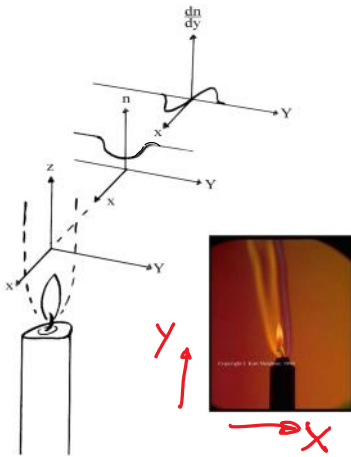

Figure 2. The Refractive Index Gradient Above a Candle

Copyright J. Kim Vandiver, 2002

Shadowgraphy:

constructive and destructive interference from disturbed parallel light

schlieren: schlieren is just a German noun, not somebody's name.

Selectively remove constructive or destructive interference from disturbed parallel light.
Higher contrast, controlled sensitivity to ∇ gradient directions

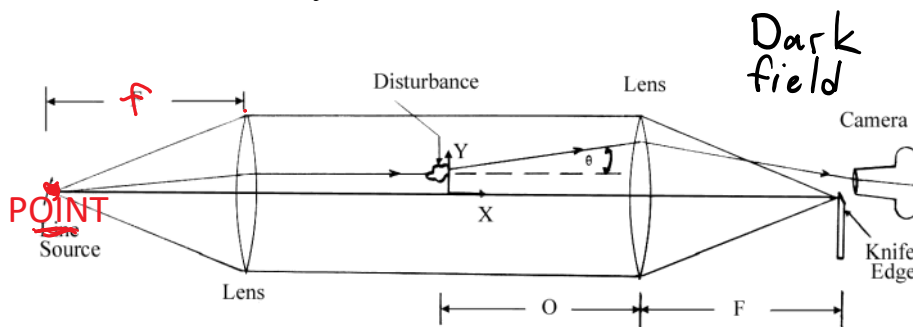

Figure 3. Schlieren System with a Small Disturbance

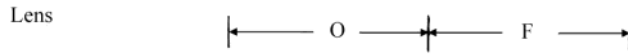

Figure 3. Schlieren System with a Small Disturbance

Copyright J. Kim Vandiver, 2002

Clicker: What would camera or your eyes see looking straight at parallel light, with the camera lens focused at infinity?
 Hint: what natural light sources do you know that emit parallel light? What do they look like?
 Hint 2: what does the lens law say about light entering parallel to the optical axis?

- A) Uniform brightness 14%
- B) Point of light 64%
- C) Small dot 23%
- D) Something else -

Stars: the light is parallel, and they look like points of light in a dark field.

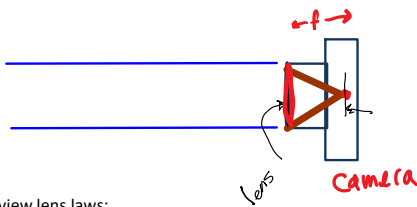

Let's review lens laws:

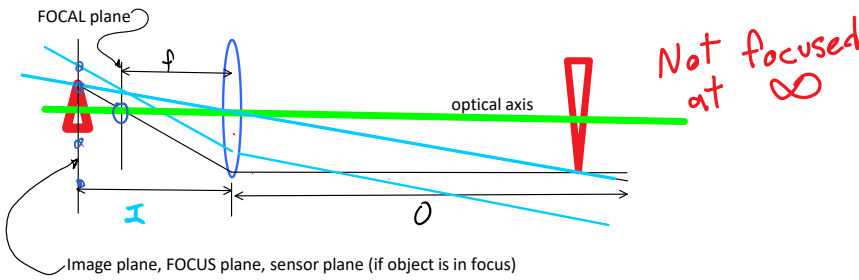

Lens Laws

- 1) light through center of lens is undeflected
- 2) light parallel to axis goes through focal point ≠ focus point
- 3) all light entering lens at a given direction ends up at the same point in the focal plane (**not** focus plane)

Focus equation

$$\frac{1}{f} = \frac{1}{O} + \frac{1}{I}$$

f = focal length
O = dist. Lens → object
I = dist. Lens → image (sensor)

Think pair share: Where is lens relative to sensor when focus is at infinity?

Back to schlieren and shadowgraphy: What does the camera see in this case? No disturbance, no knife edge

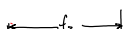

Back to schlieren and shadowgraphy: What does the camera see in this case? No disturbance, no knife edge

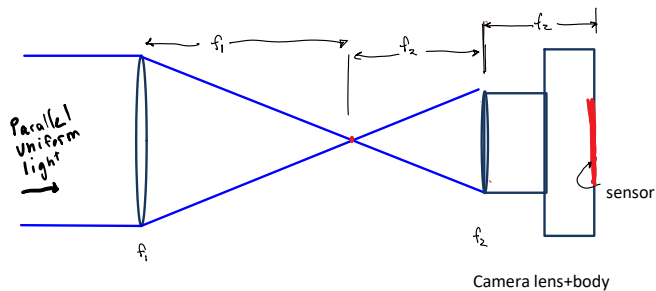

- a. Uniform brightness 86%
- b. Point of light 14%
- c. Small dot
- d. Something else

Hint: ray optics are reversible.

Now, deflect some of those light rays. Would add light in some areas, reduce it on others.

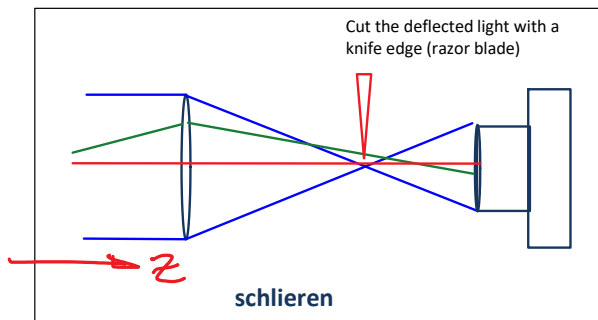
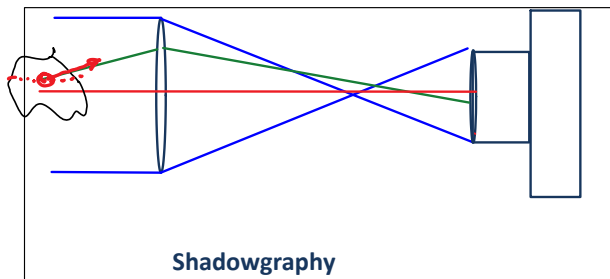

By Foucault, 1859

Bright field

Transparent target blocks center only

Shadowgraph Equation

$$\frac{\Delta I}{I} = l \int_{z_1}^{z_2} \left(\frac{\partial^2}{\partial x^2} + \frac{\partial^2}{\partial y^2} \right) (\ln \eta) dz$$

Shadowgraph, sensitive to 2nd derivative of η

- Relative light intensity at exit.
- Light propagates in Z direction

$I(x, y)$

Integrated along line of sight. Drawback for looking at 3-d phenomena

Ref: 1. Wolfgang Merzkirch, *Flow Visualization, Second Edition*, 2nd ed. (Academic Press, 1987).

Similar math for schlieren, is sensitive to first derivative; to gradients in temperature. Has higher contrast, visibility; deflected light is not adding to or confusing light field.

Variants:

(razor blade or colored transparency)

has higher contrast, visibility, deflected light is not adding to or confusing light field.

Variants:

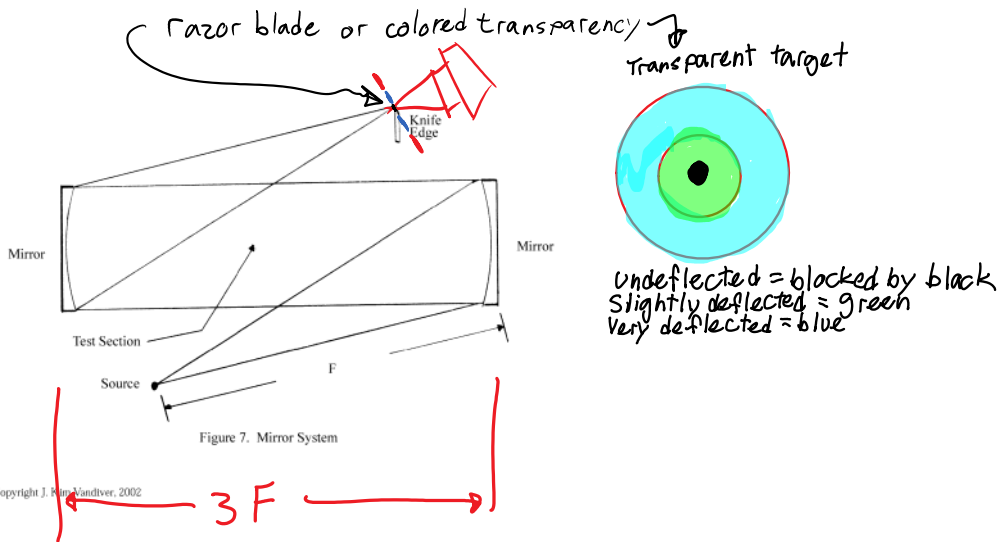

Z fold with mirrors; saves space, cost. Want space between mirrors to be $3 \times f$
Either spherical or parabolic mirrors work.

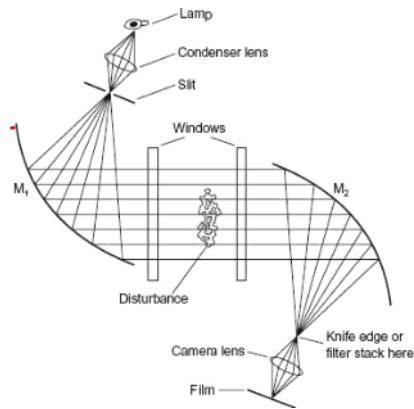

Pasted from
<http://2.bp.blogspot.com/_JUESvkRXuK0/SQZ0JdkMBAI/AAAAAAAAABPk/OGvKULVzNJ4/s320/schlieren.gif>

Single mirror system

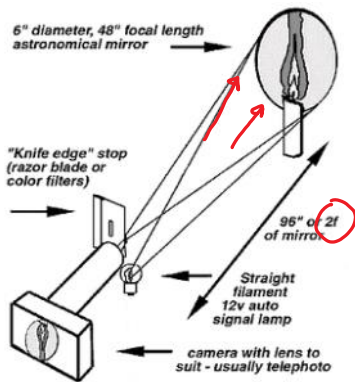

Pasted from
<<http://www.ian.org/Schlieren/SchlierenDiagram.png>>

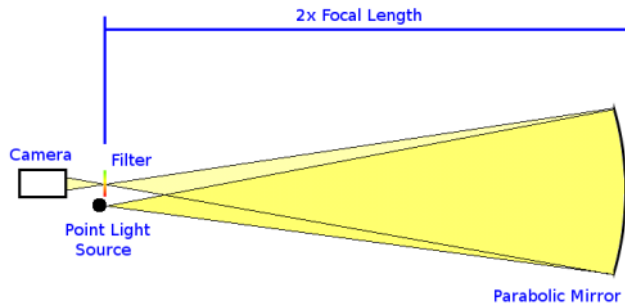

Emissions from Musicians project uses this method.
<https://vimeo.com/showcase/7707430>

<https://m.youtube.com/watch?v=BPwdlEgLn5Q> Smarter Every Day; high speed video of shock waves from bullets

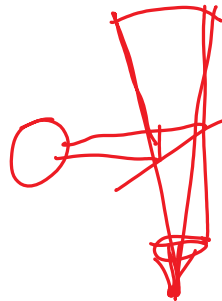
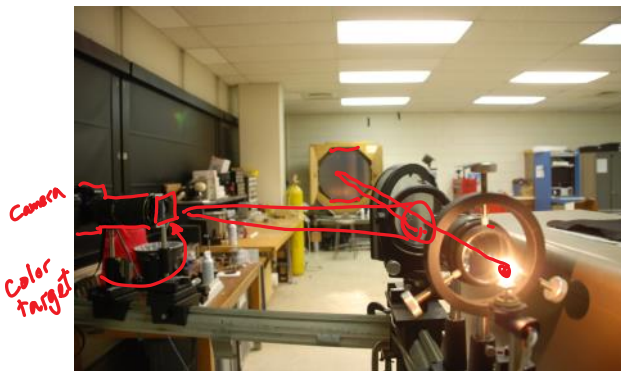

Gas Dynamics lab at Penn State University
 Prof. Gary Settles, author of
Schlieren & Shadowgraph Techniques, Corrected. (Springer, 2001).

<file:///C:/Users/hertzber/Documents/01CLASSES/FlowVis/Miscimages/Settles/SchlierenVisit/DSC_0324.AVI> My visit in March 2011

BOS = Background Oriented Schlieren

Uses patterned background instead of mirror, any random lighting. View of background will be distorted by η field. Take two images and do cross correlation, like PIV.

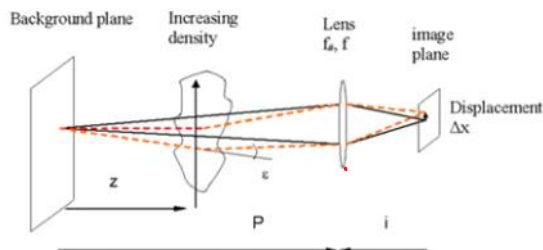

http://www.dlr.de/as/en/desktopopdefault.aspx?tabid-183/251_read-2726/

<http://www.mne.psu.edu/psgdl/Res-Optical.html>

The thermal plume generated from a hot truck engine is visualized against a background of corn. The (a) original image is compared to one recorded 7 ms later to determine the (b) horizontal pixel shift. The contour plot of horizontal pixel shift in a BOS image is optically equivalent to a vertical knife-edge cutoff in traditional schlieren.

Pasted from <<http://www.mne.psu.edu/psgdl/Res-Optical.html>>

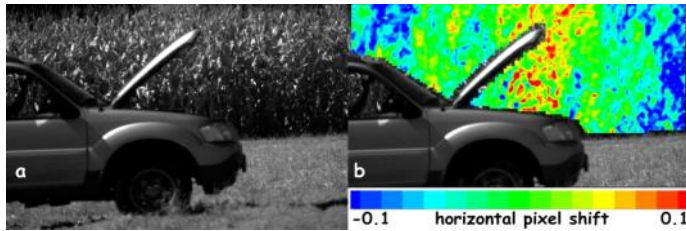

Hargather, Michael, and Gary S. Settles. "BACKGROUND-ORIENTED SCHLIEREN VISUALIZATION OF HEATING AND VENTILATION FLOWS: HVAC-BOS. Paper 266." In *ISFV14 - 14th International Symposium on Flow Visualization*, 1–8. EXCO Daegu, Korea, 2010.

Hargather, Michael John, and Gary S. Settles. "Natural-background-oriented Schlieren Imaging." *Experiments in Fluids* 48, no. 1 (January 1, 2010): 59–68. doi:10.1007/s00348-009-0709-3.

Software for this is ~ \$10,000 from LaVision. Or open source: <http://www.openpiv.net/bos/>

Focusing schlieren

<http://people.rit.edu/andpph/text-schlieren-focus.html>

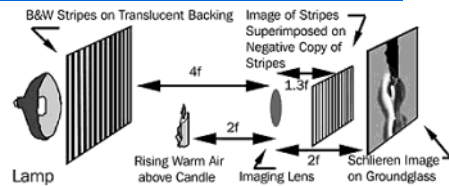

<https://www.youtube.com/watch?v=DYx2xLLrUyg> ice cube in a fishtank, by Spectabit:

<http://www.spectabit.com/index.php/product-types>

Now, an even simpler method, using an encoded light field:

Light Field Background Oriented Schlieren Photography (LFBOS)

<http://www.cs.ubc.ca/nest/imager/tr/2011/LFBOS/>

Klemkowsky, Jenna N., Timothy W. Fahringer, Christopher J. Clifford, Brett F. Bathel, and Brian S. Thurow. "Plenoptic Background Oriented Schlieren Imaging." *Measurement Science and Technology* 28, no. 9 (2017): 095404. <https://doi.org/10.1088/1361-6501/aa7f3d>. In Zotero library.

We have two sets of 4" diameter mirrors; would love to see 3D stereoscopic schlieren.